

# 3GPP TS 38.322 V16.2.0 (2020-12)

*Technical Specification*

**3rd Generation Partnership Project;  
Technical Specification Group Radio Access Network;  
NR;  
Radio Link Control (RLC) protocol specification**

**(Release 16)**



The present document has been developed within the 3rd Generation Partnership Project (3GPP™) and may be further elaborated for the purposes of 3GPP. The present document has not been subject to any approval process by the 3GPP Organizational Partners and shall not be implemented. This Specification is provided for future development work within 3GPP only. The Organizational Partners accept no liability for any use of this Specification. Specifications and Reports for implementation of the 3GPP™ system should be obtained via the 3GPP Organizational Partners' Publications Offices.

**3GPP**

Postal address

3GPP support office address

650 Route des Lucioles - Sophia Antipolis  
Valbonne - FRANCE  
Tel.: +33 4 92 94 42 00 Fax: +33 4 93 65 47 16

Internet

<http://www.3gpp.org>

***Copyright Notification***

No part may be reproduced except as authorized by written permission.  
The copyright and the foregoing restriction extend to reproduction in all media.

© 2020, 3GPP Organizational Partners (ARIB, ATIS, CCSA, ETSI, TSDSI, TTA, TTC).  
All rights reserved.

UMTS™ is a Trade Mark of ETSI registered for the benefit of its members  
3GPP™ is a Trade Mark of ETSI registered for the benefit of its Members and of the 3GPP Organizational Partners  
LTE™ is a Trade Mark of ETSI registered for the benefit of its Members and of the 3GPP Organizational Partners  
GSM® and the GSM logo are registered and owned by the GSM Association

---

# Contents

Foreword.....	5
1 Scope.....	6
2 References.....	6
3 Definitions, symbols and abbreviations.....	6
3.1 Definitions.....	6
3.2 Abbreviations.....	6
4 General.....	7
4.1 Introduction.....	7
4.2 RLC architecture.....	7
4.2.1 RLC entities.....	7
4.2.1.1 TM RLC entity.....	8
4.2.1.1.1 General.....	8
4.2.1.1.2 Transmitting TM RLC entity.....	9
4.2.1.1.3 Receiving TM RLC entity.....	9
4.2.1.2 UM RLC entity.....	9
4.2.1.2.1 General.....	9
4.2.1.2.2 Transmitting UM RLC entity.....	10
4.2.1.2.3 Receiving UM RLC entity.....	10
4.2.1.3 AM RLC entity.....	10
4.2.1.3.1 General.....	10
4.2.1.3.2 Transmitting side.....	11
4.2.1.3.3 Receiving side.....	12
4.3 Services.....	12
4.3.1 Services provided to upper layers.....	12
4.3.2 Services expected from lower layers.....	12
4.4 Functions.....	12

5	Procedures.....	13
5.1	RLC entity handling.....	13
5.1.1	RLC entity establishment.....	13
5.1.2	RLC entity re-establishment.....	13
5.1.3	RLC entity release.....	13
5.2	Data transfer procedures.....	13
5.2.1	TM data transfer.....	13
5.2.1.1	Transmit operations.....	13
5.2.1.1.1	General.....	13
5.2.1.2	Receive operations.....	14
5.2.1.2.1	General.....	14
5.2.2	UM data transfer.....	14
5.2.2.1	Transmit operations.....	14
5.2.2.1.1	General.....	14
5.2.2.2	Receive operations.....	14
5.2.2.2.1	General.....	14
5.2.2.2.2	Actions when an UMD PDU is received from lower layer.....	14
5.2.2.2.3	Actions when an UMD PDU is placed in the reception buffer.....	15
5.2.2.2.4	Actions when <i>t</i> -Reassembly expires.....	15
5.2.3	AM data transfer.....	16
5.2.3.1	Transmit operations.....	16
5.2.3.1.1	General.....	16
5.2.3.2	Receive operations.....	16
5.2.3.2.1	General.....	16
5.2.3.2.2	Actions when an AMD PDU is received from lower layer.....	17
5.2.3.2.3	Actions when an AMD PDU is placed in the reception buffer.....	17
5.2.3.2.4	Actions when <i>t</i> -Reassembly expires.....	18
5.3	ARQ procedures.....	18
5.3.1	General.....	18
5.3.2	Retransmission.....	18
5.3.3	Polling.....	19

5.3.3.1	General.....	19
5.3.3.2	Transmission of a AMD PDU.....	19
5.3.3.3	Reception of a STATUS report.....	20
5.3.3.4	Expiry of <i>t-PollRetransmit</i> .....	20
5.3.4	Status reporting.....	20
5.4	SDU discard procedures.....	21
5.5	Data volume calculation.....	21
5.6	Handling of unknown, unforeseen and erroneous protocol data.....	22
5.6.1	Reception of PDU with reserved or invalid values.....	22
6	Protocol data units, formats and parameters.....	22
6.1	Protocol data units.....	22
6.1.1	General.....	22
6.1.2	RLC data PDU.....	22
6.1.3	RLC control PDU.....	22
6.2	Formats and parameters.....	22
6.2.1	General.....	22
6.2.2	Formats.....	22
6.2.2.1	General.....	22
6.2.2.2	TMD PDU.....	23
6.2.2.3	UMD PDU.....	23
6.2.2.4	AMD PDU.....	24
6.2.2.5	STATUS PDU.....	25
6.2.3	Parameters.....	27
6.2.3.1	General.....	27
6.2.3.2	Data field.....	27
6.2.3.3	Sequence Number (SN) field.....	27
6.2.3.4	Segmentation Info (SI) field.....	27
6.2.3.5	Segment Offset (SO) field.....	27
6.2.3.6	Data/Control (D/C) field.....	28
6.2.3.7	Polling bit (P) field.....	28
6.2.3.8	Reserved (R) field.....	28

6.2.3.9	Control PDU Type (CPT) field.....	28
6.2.3.10	Acknowledgement SN (ACK_SN) field.....	28
6.2.3.11	Extension bit 1 (E1) field.....	29
6.2.3.12	Negative Acknowledgement SN (NACK_SN) field.....	29
6.2.3.13	Extension bit 2 (E2) field.....	29
6.2.3.14	SO start (SOstart) field.....	29
6.2.3.15	SO end (SOend) field.....	29
6.2.3.16	Extension bit 3 (E3) field.....	30
6.2.3.17	NACK range field.....	30
7	Variables, constants and timers.....	30
7.1	State variables.....	30
7.2	Constants.....	32
7.3	Timers.....	32
7.4	Configurable parameters.....	32
<b>Annex A (informative): Change history.....</b>		<b>33</b>



---

# Foreword

This Technical Specification has been produced by the 3rd Generation Partnership Project (3GPP).

The contents of the present document are subject to continuing work within the TSG and may change following formal TSG approval. Should the TSG modify the contents of the present document, it will be re-released by the TSG with an identifying change of release date and an increase in version number as follows:

Version x.y.z

where:

- x the first digit:
  - 1 presented to TSG for information;
  - 2 presented to TSG for approval;
  - 3 or greater indicates TSG approved document under change control.
- y the second digit is incremented for all changes of substance, i.e. technical enhancements, corrections, updates, etc.
- z the third digit is incremented when editorial only changes have been incorporated in the document.

---

# 1 Scope

The present document specifies the NR Radio Link Control (RLC) protocol for the UE – NR radio interface.

---

# 2 References

The following documents contain provisions which, through reference in this text, constitute provisions of the present document.

- References are either specific (identified by date of publication, edition number, version number, etc.) or non-specific.
- For a specific reference, subsequent revisions do not apply.
- For a non-specific reference, the latest version applies. In the case of a reference to a 3GPP document (including a GSM document), a non-specific reference implicitly refers to the latest version of that document *in the same Release as the present document*.

- [1] 3GPP TR 21.905: "Vocabulary for 3GPP Specifications".
- [2] 3GPP TS 38.300: "NR Overall Description; Stage 2".
- [3] 3GPP TS 38.321: "NR MAC protocol specification".
- [4] 3GPP TS 38.323: "NR PDCCP specification".
- [5] 3GPP TS 38.331: "NR RRC Protocol specification".
- [6] 3GPP TS 23.287: "Architecture enhancements for 5G System (5GS) to support Vehicle-to-Everything (V2X) services".
- [7] 3GPP TS 38.340: "NR; Backhaul Adaptation Protocol (BAP) specification".

---

# 3 Definitions, symbols and abbreviations

## 3.1 Definitions

For the purposes of the present document, the terms and definitions given in TR 21.905 [1] and the following apply. A term defined in the present document takes precedence over the definition of the same term, if any, in TR 21.905 [1].

**Data field element:** An RLC SDU or an RLC SDU segment that is mapped to the Data field.

**RLC data volume:** The amount of data available for transmission in an RLC entity.

**RLC SDU segment:** A segment of an RLC SDU.

**NR sidelink communication:** AS functionality enabling at least V2X Communication as defined in TS 23.287 [6], between two or more nearby UEs, using NR technology but not traversing any network node.

## 3.2 Abbreviations

For the purposes of the present document, the abbreviations given in TR 21.905 [1] and the following apply. An abbreviation defined in the present document takes precedence over the definition of the same abbreviation, if any, in TR 21.905 [1].

AM	Acknowledged Mode
AMD	AM Data
ARQ	Automatic Repeat request
gNB	NR Node B
PDU	Protocol Data Unit
RLC	Radio Link Control
SBCCH	Sidelink Broadcast Control Channel
SCCH	Sidelink Control Channel
SDU	Service Data Unit
SN	Sequence Number
STCH	Sidelink Traffic Channel
TB	Transport Block
TM	Transparent Mode
TMD	TM Data
UE	User Equipment
UM	Unacknowledged Mode
UMD	UM Data

---

## 4 General

### 4.1 Introduction

The objective is to describe the RLC architecture and the RLC entities from a functional point of view.

### 4.2 RLC architecture

#### 4.2.1 RLC entities

The description in this sub clause is a model and does not specify or restrict implementations.

RRC is generally in control of the RLC configuration.

Functions of the RLC sub layer are performed by RLC entities. For an RLC entity configured at the gNB, there is a peer RLC entity configured at the UE and vice versa. In NR sidelink communication, for an RLC entity configured at the transmitting UE, there is a peer RLC entity configured at each receiving UE.

An RLC entity receives/delivers RLC SDUs from/to upper layer and sends/receives RLC PDUs to/from its peer RLC entity via lower layers.

An RLC PDU can either be an RLC data PDU or an RLC control PDU. If an RLC entity receives RLC SDUs from upper layer, it receives them through a single RLC channel between RLC and upper layer, and after forming RLC data PDUs from the received RLC SDUs, the RLC entity submits the RLC data PDUs to lower layer through a single logical channel. If an RLC entity receives RLC data PDUs from lower layer, it receives them through a single logical channel, and after forming RLC SDUs from the received RLC data PDUs, the RLC entity delivers the RLC SDUs to upper layer through a single RLC channel between RLC and upper layer. If an RLC entity submits/receives RLC control PDUs

to/from lower layer, it submits/receives them through the same logical channel it submits/receives the RLC data PDUs through.

NOTE 1: In case the upper layer is BAP as defined in TS 38.340 [7], an RLC channel refers to a Backhaul RLC channel.

An RLC entity can be configured to perform data transfer in one of the following three modes: Transparent Mode (TM), Unacknowledged Mode (UM) or Acknowledged Mode (AM). Consequently, an RLC entity is categorized as a TM RLC entity, an UM RLC entity or an AM RLC entity depending on the mode of data transfer that the RLC entity is configured to provide.

A TM RLC entity is configured either as a transmitting TM RLC entity or a receiving TM RLC entity. The transmitting TM RLC entity receives RLC SDUs from upper layer and sends RLC PDUs to its peer receiving TM RLC entity via lower layers. The receiving TM RLC entity delivers RLC SDUs to upper layer and receives RLC PDUs from its peer transmitting TM RLC entity via lower layers.

An UM RLC entity is configured either as a transmitting UM RLC entity or a receiving UM RLC entity. The transmitting UM RLC entity receives RLC SDUs from upper layer and sends RLC PDUs to its peer receiving UM RLC entity via lower layers. The receiving UM RLC entity delivers RLC SDUs to upper layer and receives RLC PDUs from its peer transmitting UM RLC entity via lower layers.

An AM RLC entity consists of a transmitting side and a receiving side. The transmitting side of an AM RLC entity receives RLC SDUs from upper layer and sends RLC PDUs to its peer AM RLC entity via lower layers. The receiving side of an AM RLC entity delivers RLC SDUs to upper layer and receives RLC PDUs from its peer AM RLC entity via lower layers.

Figure 4.2.1-1 illustrates the overview model of the RLC sub layer.

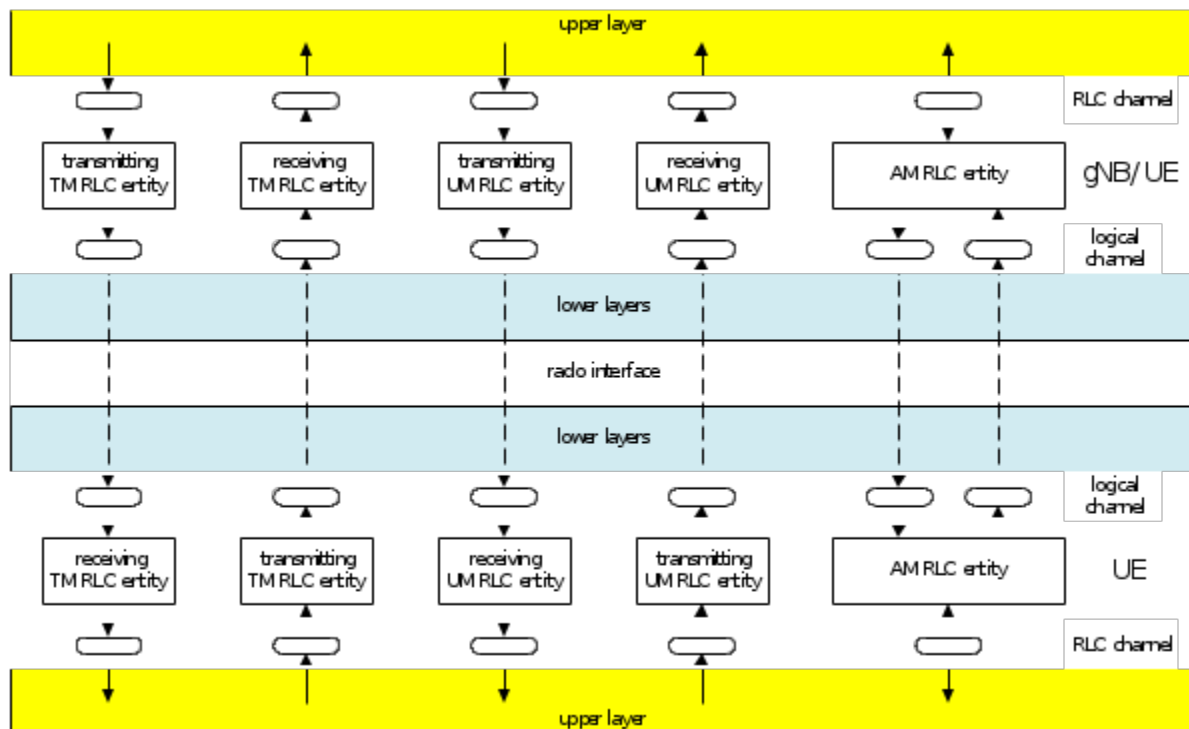

Figure 4.2.1-1: Overview model of the RLC sub layer

RLC SDUs of variable sizes which are byte aligned (i.e. multiple of 8 bits) are supported for all RLC entity types (i.e. TM, UM and AM RLC entity).

Each RLC SDU is used to construct an RLC PDU without waiting for notification from the lower layer (i.e., by MAC) of a transmission opportunity. In the case of UM and AM RLC entities, an RLC SDU may be segmented and transported using two or more RLC PDUs based on the notification(s) from the lower layer.

RLC PDUs are submitted to lower layer only when a transmission opportunity has been notified by lower layer (i.e. by MAC).

NOTE 2: The UE should aim to prevent excessive non-consecutive RLC PDUs in a MAC PDU when the UE is requested to generate more than one MAC PDU.

Description of different RLC entity types are provided below.

#### 4.2.1.1 TM RLC entity

##### 4.2.1.1.1 General

A TM RLC entity can be configured to submit/receive RLC PDUs through the following logical channels:

- BCCH, DL/UL CCCH, PCCH, and SBCCH.

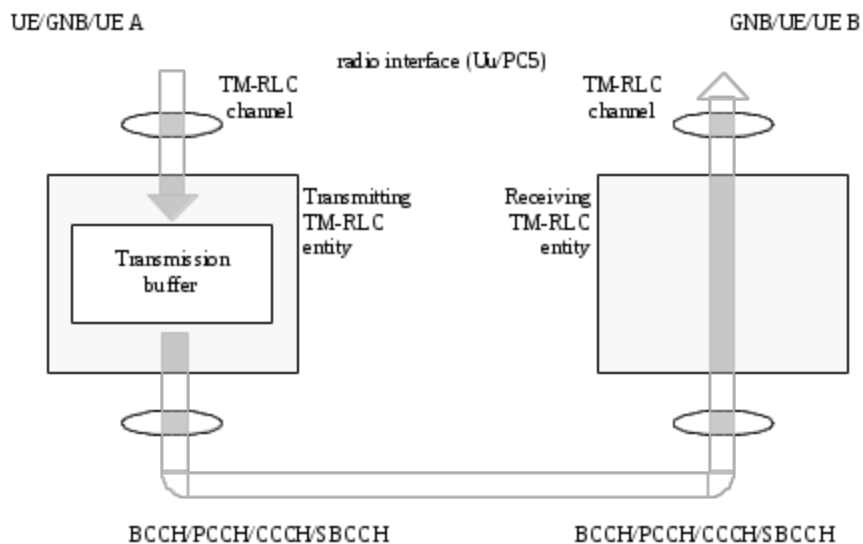

**Figure 4.2.1.1.1-1: Model of two transparent mode peer entities**

A TM RLC entity submits/receives the following RLC data PDU:

- TMD PDU.

##### 4.2.1.1.2 Transmitting TM RLC entity

When a transmitting TM RLC entity forms TMD PDUs from RLC SDUs, it shall:

- not segment the RLC SDUs;
- not include any RLC headers in the TMD PDUs.

##### 4.2.1.1.3 Receiving TM RLC entity

When a receiving TM RLC entity receives TMD PDUs, it shall:

- deliver the TMD PDUs (which are just RLC SDUs) to upper layer.

#### 4.2.1.2 UM RLC entity

##### 4.2.1.2.1 General

An UM RLC entity can be configured to submit/receive RLC PDUs through the following logical channels:

- DL/UL DTCH, SCCH, and STCH.

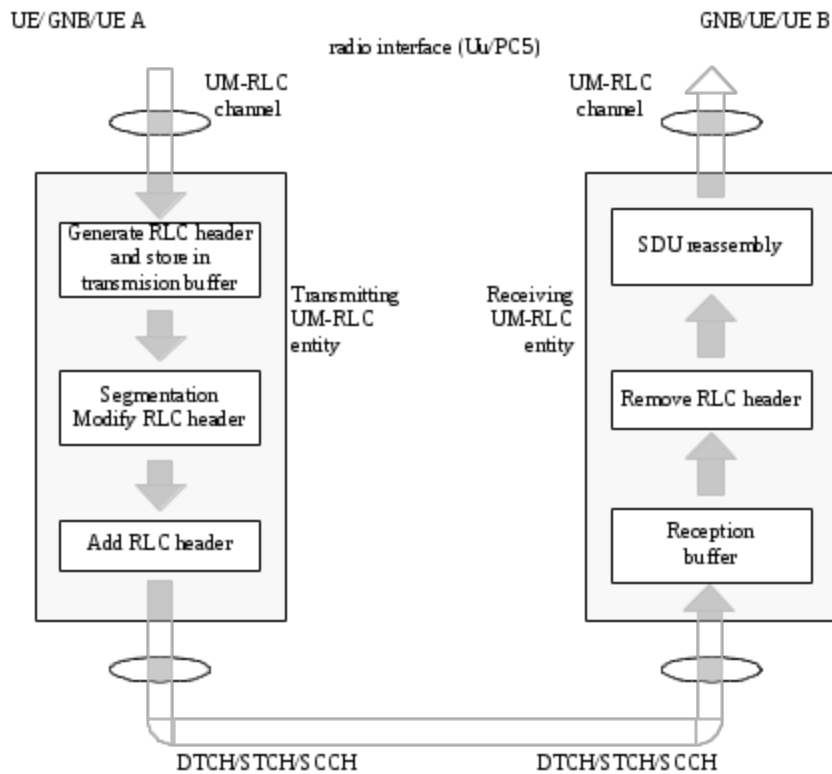

**Figure 4.2.1.2.1-1: Model of two unacknowledged mode peer entities**

An UM RLC entity submits/receives the following RLC data PDU:

- UMD PDU.

An UMD PDU contains either one complete RLC SDU or one RLC SDU segment.

NOTE: For groupcast and broadcast of NR sidelink communication only uni-directional UM mode is supported.

##### 4.2.1.2.2 Transmitting UM RLC entity

The transmitting UM RLC entity generates UMD PDU(s) for each RLC SDU. It shall include relevant RLC headers in the UMD PDU. When notified of a transmission opportunity by the lower layer, the transmitting UM RLC entity shall segment the RLC SDUs, if needed, so that the corresponding UMD PDUs, with RLC headers updated as needed, fit within the total size of RLC PDU(s) indicated by lower layer.

##### 4.2.1.2.3 Receiving UM RLC entity

When a receiving UM RLC entity receives UMD PDUs, it shall:

- detect the loss of RLC SDU segments at lower layers;
- reassemble RLC SDUs from the received UMD PDUs and deliver the RLC SDUs to upper layer as soon as they are available;
- discard received UMD PDUs that cannot be re-assembled into an RLC SDU due to loss at lower layers of an UMD PDU which belonged to the particular RLC SDU.

### 4.2.1.3 AM RLC entity

#### 4.2.1.3.1 General

An AM RLC entity can be configured to submit/receive RLC PDUs through the following logical channels:

- DL/UL DCCH, DL/UL DTCH, SCCH, and STCH.

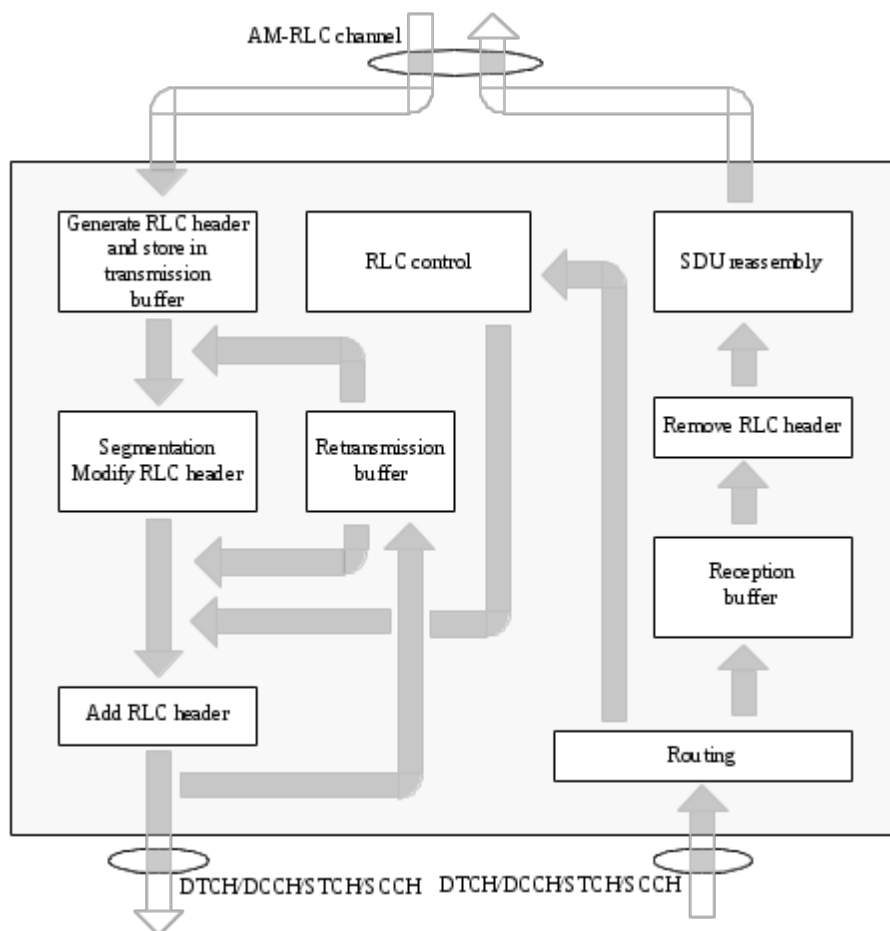

**Figure 4.2.1.3.1-1: Model of an acknowledged mode entity**

An AM RLC entity delivers/receives the following RLC data PDUs:

- AMD PDU.

An AMD PDU contains either one complete RLC SDU or one RLC SDU segment.

An AM RLC entity delivers/receives the following RLC control PDU:

- STATUS PDU.

#### 4.2.1.3.2 Transmitting side

The transmitting side of an AM RLC entity generates AMD PDU(s) for each RLC SDU. When notified of a transmission opportunity by the lower layer, the transmitting AM RLC entity shall segment the RLC SDUs, if needed, so that the corresponding AMD PDUs, with RLC headers updated as needed, fit within the total size of RLC PDU(s) indicated by lower layer.

The transmitting side of an AM RLC entity supports retransmission of RLC SDUs or RLC SDU segments (ARQ):

- if the RLC SDU or RLC SDU segment to be retransmitted (including the RLC header) does not fit within the total size of RLC PDU(s) indicated by lower layer at the particular transmission opportunity notified by lower layer, the AM RLC entity can segment the RLC SDU or re-segment the RLC SDU segments into RLC SDU segments;
- the number of re-segmentation is not limited.

When the transmitting side of an AM RLC entity forms AMD PDUs from RLC SDUs or RLC SDU segments, it shall:

- include relevant RLC headers in the AMD PDU.

#### 4.2.1.3.3 Receiving side

When the receiving side of an AM RLC entity receives AMD PDUs, it shall:

- detect whether or not the AMD PDUs have been received in duplication, and discard duplicated AMD PDUs;
- detect the loss of AMD PDUs at lower layers and request retransmissions to its peer AM RLC entity;
- reassemble RLC SDUs from the received AMD PDUs and deliver the RLC SDUs to upper layer as soon as they are available.

## 4.3 Services

### 4.3.1 Services provided to upper layers

The following services are provided by RLC to upper layer:

- TM data transfer;
- UM data transfer;
- AM data transfer, including indication of successful delivery of upper layers PDUs.

### 4.3.2 Services expected from lower layers

The following services are expected by RLC from lower layer (i.e. MAC):

- data transfer;
- notification of a transmission opportunity, together with the total size of the RLC PDU(s) to be transmitted in the transmission opportunity.

## 4.4 Functions

The following functions are supported by the RLC sub layer:



- transfer of upper layer PDUs;
- error correction through ARQ (only for AM data transfer);
- segmentation and reassembly of RLC SDUs (only for UM and AM data transfer);
- re-segmentation of RLC SDU segments (only for AM data transfer);
- duplicate detection (only for AM data transfer);
- RLC SDU discard (only for UM and AM data transfer);
- RLC re-establishment;
- Protocol error detection (only for AM data transfer).

---

## 5 Procedures

### 5.1 RLC entity handling

#### 5.1.1 RLC entity establishment

When upper layers request an RLC entity establishment, the UE shall:

- establish a RLC entity;
- set the state variables of the RLC entity to initial values;
- follow the procedures in clause 5.2.

For NR sidelink groupcast and broadcast, when receiving the first UMD PDU from a Source Layer 2 ID and Destination Layer 2 ID pair for an LCID, and there is not yet a corresponding receiving RLC entity for a radio bearer, the UE shall:

- establish a receiving RLC entity;
- set the state variables of the RLC entity to initial values;
- follow the procedures in clause 5.2.

#### 5.1.2 RLC entity re-establishment

When upper layers request an RLC entity re-establishment, the UE shall:

- discard all RLC SDUs, RLC SDU segments, and RLC PDUs, if any;
- stop and reset all timers;
- reset all state variables to their initial values.

#### 5.1.3 RLC entity release

When upper layers request an RLC entity release, the UE shall:

- discard all RLC SDUs, RLC SDU segments, and RLC PDUs, if any;

- release the RLC entity.

NOTE: For groupcast and broadcast of NR sidelink communication, the receiving UM RLC entity release is up to UE implementation.

## 5.2 Data transfer procedures

### 5.2.1 TM data transfer

#### 5.2.1.1 Transmit operations

##### 5.2.1.1.1 General

When submitting a new TMD PDU to lower layer, the transmitting TM RLC entity shall:

- submit an RLC SDU without any modification to lower layer.

#### 5.2.1.2 Receive operations

##### 5.2.1.2.1 General

When receiving a new TMD PDU from lower layer, the receiving TM RLC entity shall:

- deliver the TMD PDU without any modification to upper layer.

### 5.2.2 UM data transfer

#### 5.2.2.1 Transmit operations

##### 5.2.2.1.1 General

When submitting a UMD PDU to lower layer, the transmitting UM RLC entity shall:

- if the UMD PDU contains a segment of an RLC SDU, set the SN of the UMD PDU to TX\_Next;
- if the UMD PDU contains a segment that maps to the last byte of an RLC SDU, then increment TX\_Next by one.

#### 5.2.2.2 Receive operations

##### 5.2.2.2.1 General

The receiving UM RLC entity shall maintain a reassembly window according to state variable RX\_Next\_Highest as follows:

- a SN falls within the reassembly window if  $(RX\_Next\_Highest - UM\_Window\_Size) \leq SN < RX\_Next\_Highest$ ;
- a SN falls outside of the reassembly window otherwise.

When receiving an UMD PDU from lower layer, the receiving UM RLC entity shall:

- either deliver the UMD PDU to upper layer after removing the RLC header, discard the received UMD PDU, or place it in the reception buffer (see sub clause 5.2.2.2.2);
- if the received UMD PDU was placed in the reception buffer:
  - update state variables, reassemble and deliver RLC SDUs to upper layer and start/stop *t-Reassembly* as needed (see sub clause 5.2.2.2.3).

When *t-Reassembly* expires, the receiving UM RLC entity shall:

- update state variables, discard RLC SDU segments and start *t-Reassembly* as needed (see sub clause 5.2.2.2.4).

#### 5.2.2.2.2 Actions when an UMD PDU is received from lower layer

When an UMD PDU is received from lower layer, the receiving UM RLC entity shall:

- if the UMD PDU header does not contain an SN:
  - remove the RLC header and deliver the RLC SDU to upper layer.
- else if  $(RX\_Next\_Highest - UM\_Window\_Size) \leq SN < RX\_Next\_Reassembly$ :
  - discard the received UMD PDU.
- else:
  - place the received UMD PDU in the reception buffer.

#### 5.2.2.2.3 Actions when an UMD PDU is placed in the reception buffer

When an UMD PDU with  $SN = x$  is placed in the reception buffer, the receiving UM RLC entity shall:

- if all byte segments with  $SN = x$  are received:
  - reassemble the RLC SDU from all byte segments with  $SN = x$ , remove RLC headers and deliver the reassembled RLC SDU to upper layer;
  - if  $x = RX\_Next\_Reassembly$ :
    - update  $RX\_Next\_Reassembly$  to the SN of the first  $SN > current\ RX\_Next\_Reassembly$  that has not been reassembled and delivered to upper layer.
- else if  $x$  falls outside of the reassembly window:
  - update  $RX\_Next\_Highest$  to  $x + 1$ ;
  - discard any UMD PDUs with SN that falls outside of the reassembly window;
  - if  $RX\_Next\_Reassembly$  falls outside of the reassembly window:
    - set  $RX\_Next\_Reassembly$  to the SN of the first  $SN \geq (RX\_Next\_Highest - UM\_Window\_Size)$  that has not been reassembled and delivered to upper layer.
- if *t-Reassembly* is running:
  - if  $RX\_Timer\_Trigger \leq RX\_Next\_Reassembly$ ; or
  - if  $RX\_Timer\_Trigger$  falls outside of the reassembly window and  $RX\_Timer\_Trigger$  is not equal to  $RX\_Next\_Highest$ ; or

- if  $RX\_Next\_Highest = RX\_Next\_Reassembly + 1$  and there is no missing byte segment of the RLC SDU associated with  $SN = RX\_Next\_Reassembly$  before the last byte of all received segments of this RLC SDU:
  - stop and reset  $t-Reassembly$ .
- if  $t-Reassembly$  is not running (includes the case when  $t-Reassembly$  is stopped due to actions above):
  - if  $RX\_Next\_Highest > RX\_Next\_Reassembly + 1$ ; or
  - if  $RX\_Next\_Highest = RX\_Next\_Reassembly + 1$  and there is at least one missing byte segment of the RLC SDU associated with  $SN = RX\_Next\_Reassembly$  before the last byte of all received segments of this RLC SDU:
    - start  $t-Reassembly$ ;
    - set  $RX\_Timer\_Trigger$  to  $RX\_Next\_Highest$ .

#### 5.2.2.2.4 Actions when t-Reassembly expires

When  $t-Reassembly$  expires, the receiving UM RLC entity shall:

- update  $RX\_Next\_Reassembly$  to the SN of the first  $SN \geq RX\_Timer\_Trigger$  that has not been reassembled;
- discard all segments with  $SN < updated\ RX\_Next\_Reassembly$ ;
- if  $RX\_Next\_Highest > RX\_Next\_Reassembly + 1$ ; or
- if  $RX\_Next\_Highest = RX\_Next\_Reassembly + 1$  and there is at least one missing byte segment of the RLC SDU associated with  $SN = RX\_Next\_Reassembly$  before the last byte of all received segments of this RLC SDU:
  - start  $t-Reassembly$ ;
  - set  $RX\_Timer\_Trigger$  to  $RX\_Next\_Highest$ .

### 5.2.3 AM data transfer

#### 5.2.3.1 Transmit operations

##### 5.2.3.1.1 General

The transmitting side of an AM RLC entity shall prioritize transmission of RLC control PDUs over AMD PDUs. The transmitting side of an AM RLC entity shall prioritize transmission of AMD PDUs containing previously transmitted RLC SDUs or RLC SDU segments over transmission of AMD PDUs containing not previously transmitted RLC SDUs or RLC SDU segments.

The transmitting side of an AM RLC entity shall maintain a transmitting window according to the state variable  $TX\_Next\_Ack$  as follows:

- a SN falls within the transmitting window if  $TX\_Next\_Ack \leq SN < TX\_Next\_Ack + AM\_Window\_Size$ ;
- a SN falls outside of the transmitting window otherwise.

The transmitting side of an AM RLC entity shall not submit to lower layer any AMD PDU whose SN falls outside of the transmitting window.

For each RLC SDU received from the upper layer, the AM RLC entity shall:

- associate a SN with the RLC SDU equal to TX\_Next and construct an AMD PDU by setting the SN of the AMD PDU to TX\_Next;
- increment TX\_Next by one.

When submitting an AMD PDU that contains a segment of an RLC SDU, to lower layer, the transmitting side of an AM RLC entity shall:

- set the SN of the AMD PDU to the SN of the corresponding RLC SDU.

The transmitting side of an AM RLC entity can receive a positive acknowledgement (confirmation of successful reception by its peer AM RLC entity) for an RLC SDU by the following:

- STATUS PDU from its peer AM RLC entity.

When receiving a positive acknowledgement for an RLC SDU with SN = x, the transmitting side of an AM RLC entity shall:

- send an indication to the upper layers of successful delivery of the RLC SDU;
- set TX\_Next\_Ack equal to the SN of the RLC SDU with the smallest SN, whose SN falls within the range  $TX\_Next\_Ack \leq SN \leq TX\_Next$  and for which a positive acknowledgment has not been received yet.

## 5.2.3.2 Receive operations

### 5.2.3.2.1 General

The receiving side of an AM RLC entity shall maintain a receiving window according to the state variable RX\_Next as follows:

- a SN falls within the receiving window if  $RX\_Next \leq SN < RX\_Next + AM\_Window\_Size$ ;
- a SN falls outside of the receiving window otherwise.

When receiving an AMD PDU from lower layer, the receiving side of an AM RLC entity shall:

- either discard the received AMD PDU or place it in the reception buffer (see sub clause 5.2.3.2.2);
- if the received AMD PDU was placed in the reception buffer:
  - update state variables, reassemble and deliver RLC SDUs to upper layer and start/stop *t-Reassembly* as needed (see sub clause 5.2.3.2.3).

When *t-Reassembly* expires, the receiving side of an AM RLC entity shall:

- update state variables and start *t-Reassembly* as needed (see sub clause 5.2.3.2.4).

### 5.2.3.2.2 Actions when an AMD PDU is received from lower layer

When an AMD PDU is received from lower layer, where the AMD PDU contains byte segment numbers y to z of an RLC SDU with SN = x, the receiving side of an AM RLC entity shall:

- if x falls outside of the receiving window; or
- if byte segment numbers y to z of the RLC SDU with SN = x have been received before:
  - discard the received AMD PDU.
- else:

- place the received AMD PDU in the reception buffer;
- if some byte segments of the RLC SDU contained in the AMD PDU have been received before:
  - discard the duplicate byte segments.

#### 5.2.3.2.3 Actions when an AMD PDU is placed in the reception buffer

When an AMD PDU with SN = x is placed in the reception buffer, the receiving side of an AM RLC entity shall:

- if  $x \geq \text{RX\_Next\_Highest}$ 
  - update  $\text{RX\_Next\_Highest}$  to  $x + 1$ .
- if all bytes of the RLC SDU with SN = x are received:
  - reassemble the RLC SDU from AMD PDU(s) with SN = x, remove RLC headers when doing so and deliver the reassembled RLC SDU to upper layer;
  - if  $x = \text{RX\_Highest\_Status}$ ,
    - update  $\text{RX\_Highest\_Status}$  to the SN of the first RLC SDU with SN > current  $\text{RX\_Highest\_Status}$  for which not all bytes have been received.
  - if  $x = \text{RX\_Next}$ :
    - update  $\text{RX\_Next}$  to the SN of the first RLC SDU with SN > current  $\text{RX\_Next}$  for which not all bytes have been received.
- if *t-Reassembly* is running:
  - if  $\text{RX\_Next\_Status\_Trigger} = \text{RX\_Next}$ ; or
  - if  $\text{RX\_Next\_Status\_Trigger} = \text{RX\_Next} + 1$  and there is no missing byte segment of the SDU associated with SN =  $\text{RX\_Next}$  before the last byte of all received segments of this SDU; or
  - if  $\text{RX\_Next\_Status\_Trigger}$  falls outside of the receiving window and  $\text{RX\_Next\_Status\_Trigger}$  is not equal to  $\text{RX\_Next} + \text{AM\_Window\_Size}$ :
    - stop and reset *t-Reassembly*.
- if *t-Reassembly* is not running (includes the case *t-Reassembly* is stopped due to actions above):
  - if  $\text{RX\_Next\_Highest} > \text{RX\_Next} + 1$ ; or
  - if  $\text{RX\_Next\_Highest} = \text{RX\_Next} + 1$  and there is at least one missing byte segment of the SDU associated with SN =  $\text{RX\_Next}$  before the last byte of all received segments of this SDU:
    - start *t-Reassembly*;
    - set  $\text{RX\_Next\_Status\_Trigger}$  to  $\text{RX\_Next\_Highest}$ .

#### 5.2.3.2.4 Actions when *t-Reassembly* expires

When *t-Reassembly* expires, the receiving side of an AM RLC entity shall:

- update  $\text{RX\_Highest\_Status}$  to the SN of the first RLC SDU with SN  $\geq \text{RX\_Next\_Status\_Trigger}$  for which not all bytes have been received;
- if  $\text{RX\_Next\_Highest} > \text{RX\_Highest\_Status} + 1$ : or

- if  $RX\_Next\_Highest = RX\_Highest\_Status + 1$  and there is at least one missing byte segment of the SDU associated with  $SN = RX\_Highest\_Status$  before the last byte of all received segments of this SDU:
  - start *t-Reassembly*;
  - set  $RX\_Next\_Status\_Trigger$  to  $RX\_Next\_Highest$ .

## 5.3 ARQ procedures

### 5.3.1 General

ARQ procedures are only performed by an AM RLC entity.

### 5.3.2 Retransmission

The transmitting side of an AM RLC entity can receive a negative acknowledgement (notification of reception failure by its peer AM RLC entity) for an RLC SDU or an RLC SDU segment by the following:

- STATUS PDU from its peer AM RLC entity.

When receiving a negative acknowledgement for an RLC SDU or an RLC SDU segment by a STATUS PDU from its peer AM RLC entity, the transmitting side of the AM RLC entity shall:

- if the SN of the corresponding RLC SDU falls within the range  $TX\_Next\_Ack \leq SN \leq$  the highest SN of the AMD PDU among the AMD PDUs submitted to lower layer:
  - consider the RLC SDU or the RLC SDU segment for which a negative acknowledgement was received for retransmission.

When an RLC SDU or an RLC SDU segment is considered for retransmission, the transmitting side of the AM RLC entity shall:

- if the RLC SDU or RLC SDU segment is considered for retransmission for the first time:
  - set the  $RETX\_COUNT$  associated with the RLC SDU to zero.
- else, if it (the RLC SDU or the RLC SDU segment that is considered for retransmission) is not pending for retransmission already and the  $RETX\_COUNT$  associated with the RLC SDU has not been incremented due to another negative acknowledgment in the same STATUS PDU:
  - increment the  $RETX\_COUNT$ .
- if  $RETX\_COUNT = maxRetxThreshold$ :
  - indicate to upper layers that max retransmission has been reached.

When retransmitting an RLC SDU or an RLC SDU segment, the transmitting side of an AM RLC entity shall:

- if needed, segment the RLC SDU or the RLC SDU segment;
- form a new AMD PDU which will fit within the total size of AMD PDU(s) indicated by lower layer at the particular transmission opportunity;
- submit the new AMD PDU to lower layer.

When forming a new AMD PDU, the transmitting side of an AM RLC entity shall:

- only map the original RLC SDU or RLC SDU segment to the Data field of the new AMD PDU;

- modify the header of the new AMD PDU in accordance with the description in sub clause 6.2.2.4;
- set the P field according to sub clause 5.3.3.

### 5.3.3 Polling

#### 5.3.3.1 General

An AM RLC entity can poll its peer AM RLC entity in order to trigger STATUS reporting at the peer AM RLC entity.

#### 5.3.3.2 Transmission of a AMD PDU

Upon notification of a transmission opportunity by lower layer, for each AMD PDU submitted for transmission such that the AMD PDU contains either a not previously transmitted RLC SDU or an RLC SDU segment containing not previously transmitted byte segment, the transmitting side of an AM RLC entity shall:

- increment PDU\_WITHOUT\_POLL by one;
- increment BYTE\_WITHOUT\_POLL by every new byte of Data field element that it maps to the Data field of the AMD PDU;
- if PDU\_WITHOUT\_POLL  $\geq$  pollPDU; or
- if BYTE\_WITHOUT\_POLL  $\geq$  pollByte:
  - include a poll in the AMD PDU as described below.

Upon notification of a transmission opportunity by lower layer, for each AMD PDU submitted for transmission, the transmitting side of an AM RLC entity shall:

- if both the transmission buffer and the retransmission buffer becomes empty (excluding transmitted RLC SDUs or RLC SDU segments awaiting acknowledgements) after the transmission of the AMD PDU; or
- if no new RLC SDU can be transmitted after the transmission of the AMD PDU (e.g. due to window stalling);
  - include a poll in the AMD PDU as described below.

NOTE: Empty RLC buffer (excluding transmitted RLC SDUs or RLC SDU segments awaiting acknowledgements) should not lead to unnecessary polling when data awaits in the upper layer. Details are left up to UE implementation.

To include a poll in an AMD PDU, the transmitting side of an AM RLC entity shall:

- set the P field of the AMD PDU to "1";
- set PDU\_WITHOUT\_POLL to 0;
- set BYTE\_WITHOUT\_POLL to 0.

Upon submission of an AMD PDU including a poll to lower layer, the transmitting side of an AM RLC entity shall:

- set POLL\_SN to the highest SN of the AMD PDU among the AMD PDUs submitted to lower layer;
- if *t-PollRetransmit* is not running:
  - start *t-PollRetransmit*.
- else:
  - restart *t-PollRetransmit*.



### 5.3.3.3 Reception of a STATUS report

Upon reception of a STATUS report from the receiving RLC AM entity the transmitting side of an AM RLC entity shall:

- if the STATUS report comprises a positive or negative acknowledgement for the RLC SDU with sequence number equal to POLL\_SN:
  - if *t-PollRetransmit* is running:
    - stop and reset *t-PollRetransmit*.

### 5.3.3.4 Expiry of *t-PollRetransmit*

Upon expiry of *t-PollRetransmit*, the transmitting side of an AM RLC entity shall:

- if both the transmission buffer and the retransmission buffer are empty (excluding transmitted RLC SDU or RLC SDU segment awaiting acknowledgements); or
- if no new RLC SDU or RLC SDU segment can be transmitted (e.g. due to window stalling):
  - consider the RLC SDU with the highest SN among the RLC SDUs submitted to lower layer for retransmission; or
  - consider any RLC SDU which has not been positively acknowledged for retransmission.
- include a poll in an AMD PDU as described in clause 5.3.3.2.

## 5.3.4 Status reporting

An AM RLC entity sends STATUS PDUs to its peer AM RLC entity in order to provide positive and/or negative acknowledgements of RLC SDUs (or portions of them).

Triggers to initiate STATUS reporting include:

- Polling from its peer AM RLC entity:
  - When an AMD PDU with SN = x and the P field set to "1" is received from lower layer, the receiving side of an AM RLC entity shall:
    - if the AMD PDU is to be discarded as specified in clause 5.2.3.2.2; or
    - if  $x < \text{RX\_Highest\_Status}$  or  $x \geq \text{RX\_Next} + \text{AM\_Window\_Size}$ :
      - trigger a STATUS report.
    - else:
      - delay triggering the STATUS report until  $x < \text{RX\_Highest\_Status}$  or  $x \geq \text{RX\_Next} + \text{AM\_Window\_Size}$ .

NOTE 1: This ensures that the RLC Status report is transmitted after HARQ reordering.

- Detection of reception failure of an AMD PDU
  - The receiving side of an AM RLC entity shall trigger a STATUS report when *t-Reassembly* expires.

NOTE 2: The expiry of *t-Reassembly* triggers both *RX\_Highest\_Status* to be updated and a STATUS report to be triggered, but the STATUS report shall be triggered after *RX\_Highest\_Status* is updated.

When STATUS reporting has been triggered, the receiving side of an AM RLC entity shall:

- if *t-StatusProhibit* is not running:
  - at the first transmission opportunity indicated by lower layer, construct a STATUS PDU and submit it to lower layer.
- else:
  - at the first transmission opportunity indicated by lower layer after *t-StatusProhibit* expires, construct a single STATUS PDU even if status reporting was triggered several times while *t-StatusProhibit* was running and submit it to lower layer.

When a STATUS PDU has been submitted to lower layer, the receiving side of an AM RLC entity shall:

- start *t-StatusProhibit*.

When constructing a STATUS PDU, the AM RLC entity shall:

- for the RLC SDUs with SN such that  $RX\_Next \leq SN < RX\_Highest\_Status$  that has not been completely received yet, in increasing SN order of RLC SDUs and increasing byte segment order within RLC SDUs, starting with SN = RX\_Next up to the point where the resulting STATUS PDU still fits to the total size of RLC PDU(s) indicated by lower layer:
  - for an RLC SDU for which no byte segments have been received yet:
    - include in the STATUS PDU a NACK\_SN which is set to the SN of the RLC SDU.
  - for a continuous sequence of byte segments of a partly received RLC SDU that have not been received yet:
    - include in the STATUS PDU a set of NACK\_SN, SOstart and SOend.
  - for a continuous sequence of RLC SDUs that have not been received yet:
    - include in the STATUS PDU a set of NACK\_SN and NACK range;
    - include in the STATUS PDU, if required, a pair of SOstart and SOend.
- set the ACK\_SN to the SN of the next not received RLC SDU which is not indicated as missing in the resulting STATUS PDU.

## 5.4 SDU discard procedures

When indicated from upper layer (i.e. PDCP) to discard a particular RLC SDU, the transmitting side of an AM RLC entity or the transmitting UM RLC entity shall discard the indicated RLC SDU, if neither the RLC SDU nor a segment thereof has been submitted to the lower layers. The transmitting side of an AM RLC entity shall not introduce an RLC SN gap when discarding an RLC SDU.

## 5.5 Data volume calculation

For the purpose of MAC buffer status reporting, the UE shall consider the following as RLC data volume:

- RLC SDUs and RLC SDU segments that have not yet been included in an RLC data PDU;
- RLC data PDUs that are pending for initial transmission;
- RLC data PDUs that are pending for retransmission (RLC AM).

In addition, if a STATUS PDU has been triggered and *t-StatusProhibit* is not running or has expired, the UE shall estimate the size of the STATUS PDU that will be transmitted in the next transmission opportunity, and consider this as part of RLC data volume.

## 5.6 Handling of unknown, unforeseen and erroneous protocol data

### 5.6.1 Reception of PDU with reserved or invalid values

When an RLC entity receives an RLC PDU that contains reserved or invalid values, the RLC entity shall:

- discard the received RLC PDU.

---

# 6 Protocol data units, formats and parameters

## 6.1 Protocol data units

### 6.1.1 General

RLC PDUs can be categorized into RLC data PDUs and RLC control PDUs. RLC data PDUs in sub clause 6.1.2 are used by TM, UM and AM RLC entities to transfer upper layer PDUs (i.e. RLC SDUs). RLC control PDUs in sub clause 6.1.3 are used by AM RLC entity to perform ARQ procedures.

### 6.1.2 RLC data PDU

#### a) TMD PDU

TMD PDU is used to transfer upper layer PDUs by a TM RLC entity.

#### b) UMD PDU

UMD PDU is used to transfer upper layer PDUs by an UM RLC entity.

#### c) AMD PDU

AMD PDU is used to transfer upper layer PDUs by an AM RLC entity.

### 6.1.3 RLC control PDU

#### a) STATUS PDU

STATUS PDU is used by the receiving side of an AM RLC entity to inform the peer AM RLC entity about RLC data PDUs that are received successfully, and RLC data PDUs that are detected to be lost by the receiving side of an AM RLC entity.

## 6.2 Formats and parameters

### 6.2.1 General

The formats of RLC PDUs are described in sub clause 6.2.2 and their parameters are described in sub clause 6.2.3.

## 6.2.2 Formats

### 6.2.2.1 General

RLC PDU is a bit string. In the figures in sub clause 6.2.2.2 to 6.2.2.5, bit strings are represented by tables in which the first and most significant bit is the left most bit of the first line of the table, the last and least significant bit is the rightmost bit of the last line of the table, and more generally the bit string is to be read from left to right and then in the reading order of the lines.

RLC SDUs are bit strings that are byte aligned (i.e. multiple of 8 bits) in length. An RLC SDU is included into an RLC PDU from first bit onward.

### 6.2.2.2 TMD PDU

TMD PDU consists only of a Data field and does not consist of any RLC headers.

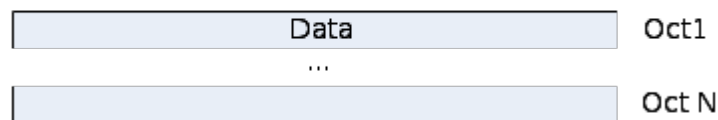

Figure 6.2.2.2-1: TMD PDU

### 6.2.2.3 UMD PDU

UMD PDU consists of a Data field and an UMD PDU header. The UMD PDU header is byte aligned.

When an UMD PDU contains a complete RLC SDU, the UMD PDU header only contains the SI and R fields.

An UM RLC entity is configured by RRC to use either a 6 bit SN or a 12 bit SN. For groupcast and broadcast of NR sidelink communication, only 6 bit SN length is configured. An UMD PDU header contains the SN field only when the corresponding RLC SDU is segmented. An UMD PDU carrying the first segment of an RLC SDU does not carry the SO field in its header. The length of the SO field is 16 bits.

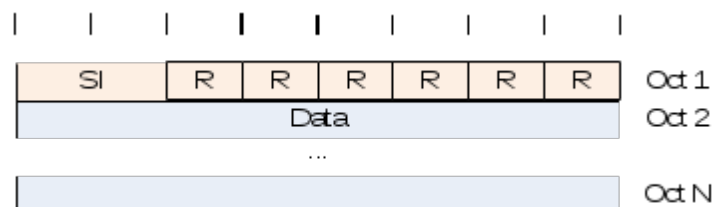

Figure 6.2.2.3-1: UMD PDU containing a complete RLC SDU

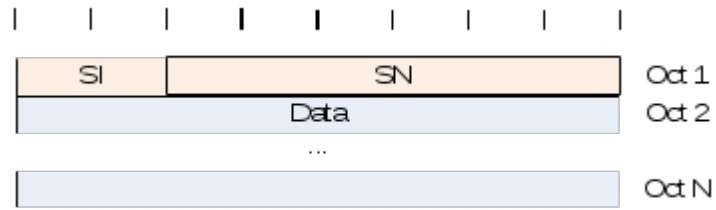

Figure 6.2.2.3-2: UMD PDU with 6 bit SN (No SO)

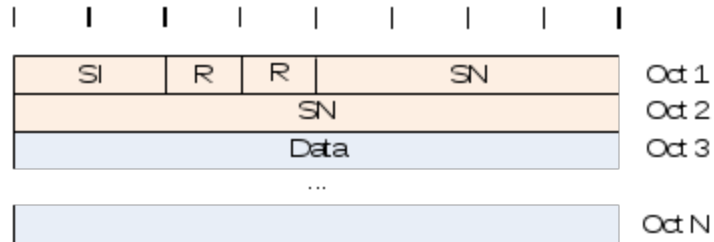

Figure 6.2.2.3-3: UMD PDU with 12 bit SN (No SO)

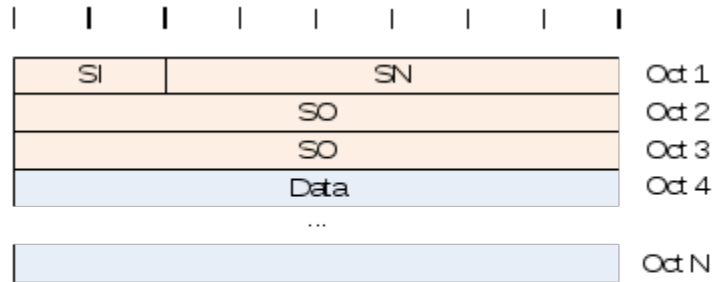

Figure 6.2.2.3-4: UMD PDU with 6 bit SN and with SO

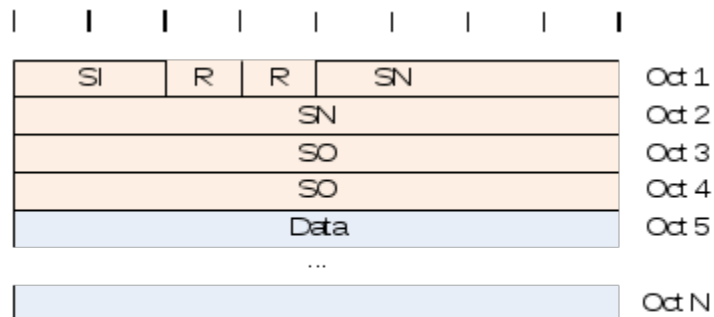

Figure 6.2.2.3-5: UMD PDU with 12 bit SN and with SO

### 6.2.2.4 AMD PDU

AMD PDU consists of a Data field and an AMD PDU header. The AMD PDU header is byte aligned.

An AM RLC entity is configured by RRC to use either a 12 bit SN or a 18 bit SN. The length of the AMD PDU header is two and three bytes respectively.

An AMD PDU header contains a D/C, a P, a SI, and a SN. An AMD PDU header contains the SO field only when the Data field consists of an RLC SDU segment which is not the first segment, in which case a 16 bit SO is present.

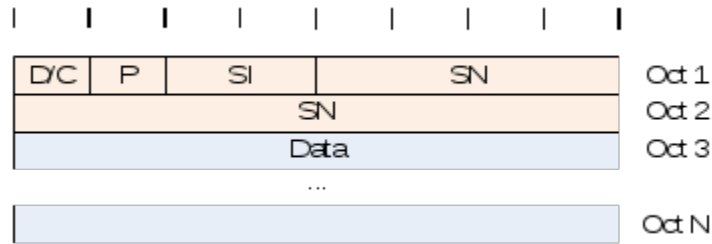

**Figure 6.2.2.4-1: AMD PDU with 12 bit SN (No SO)**

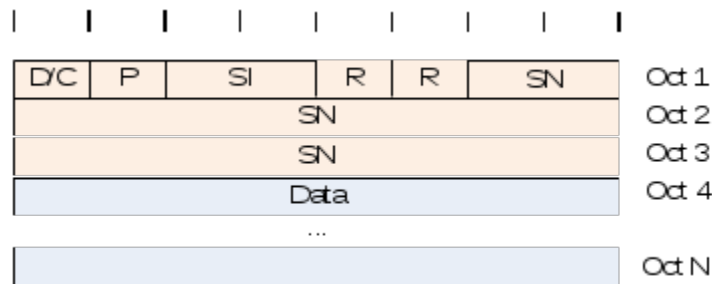

**Figure 6.2.2.4-2: AMD PDU with 18 bit SN (No SO)**

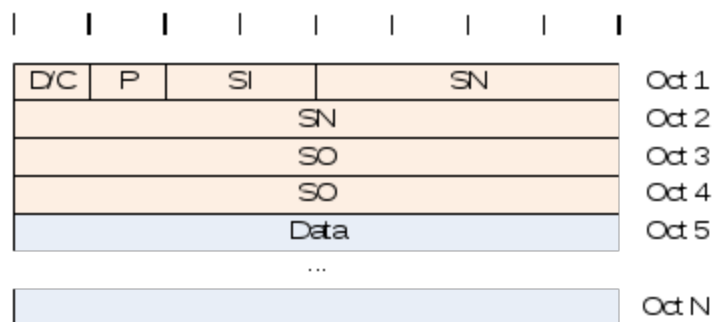

**Figure 6.2.2.4-3: AMD PDU with 12 bit SN with SO**

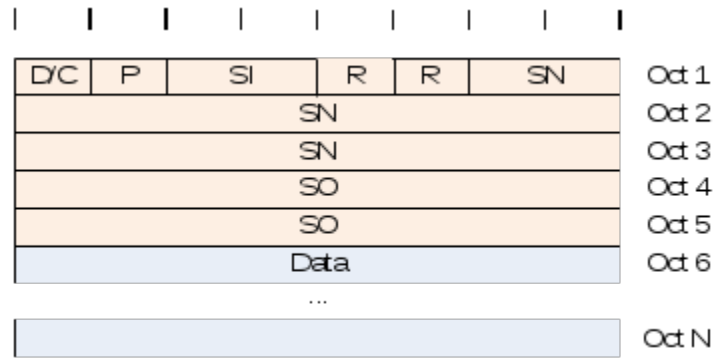

Figure 6.2.2.4-4: AMD PDU with 18 bit SN with SO

### 6.2.2.5 STATUS PDU

STATUS PDU consists of a STATUS PDU payload and an RLC control PDU header.

RLC control PDU header consists of a D/C and a CPT field.

The STATUS PDU payload starts from the first bit following the RLC control PDU header, and it consists of one ACK\_SN and one E1, zero or more sets of a NACK\_SN, an E1, an E2 and an E3, and possibly a pair of a SOstart and a SOend or a NACK range field for each NACK\_SN.

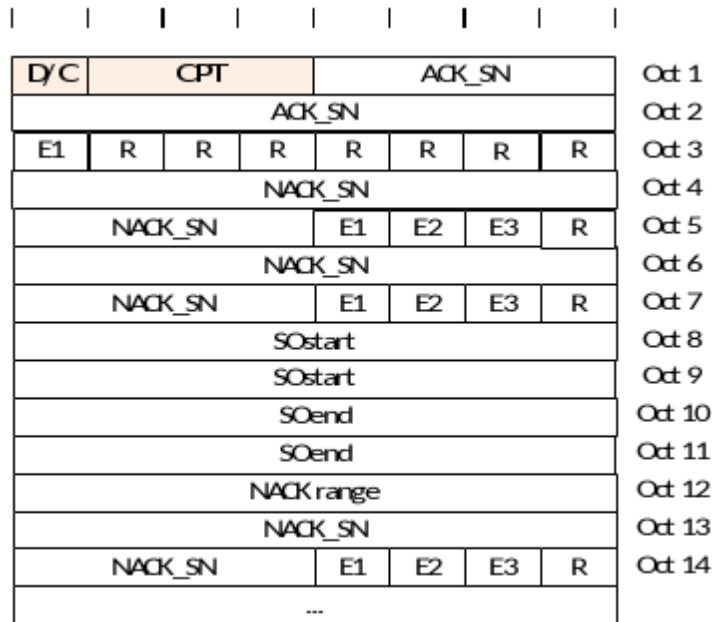

Figure 6.2.2.5-1: STATUS PDU with 12 bit SN

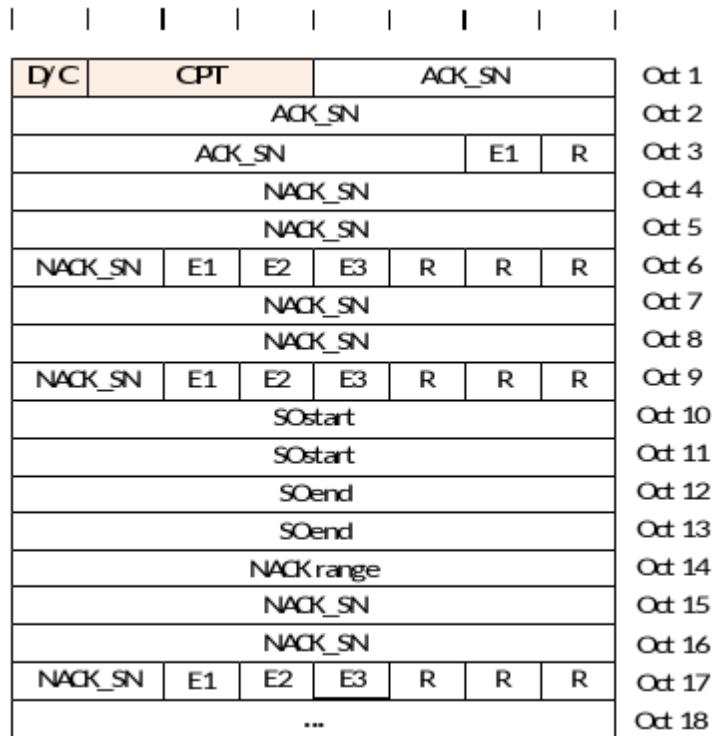

Figure 6.2.2.5-2: STATUS PDU with 18 bit SN

### 6.2.3 Parameters

#### 6.2.3.1 General

In the definition of each field in sub clauses 6.2.3.2 to 6.2.3.5, the bits in the parameters are represented in which the first and most significant bit is the left most bit and the last and least significant bit is the rightmost bit. Unless mentioned otherwise, integers are encoded in standard binary encoding for unsigned integers.

#### 6.2.3.2 Data field

Data field elements are mapped to the Data field in the order which they arrive to the RLC entity at the transmitter.

For TMD PDU, UMD PDU and AMD PDU:

- The granularity of the Data field size is one byte;
- The maximum Data field size is the maximum size of a PDCP PDU.

NOTE: In case the upper layer is BAP as specified in TS 38.340 [7], the maximum Data field size can be larger than the maximum size of a PDCP PDU.

For TMD PDU:

- Only one RLC SDU can be mapped to the Data field of one TMD PDU.

For UMD PDU, and AMD PDU:

- Either of the following can be mapped to the Data field of one UMD PDU, or AMD PDU:
  - One RLC SDU;



- One RLC SDU segment.

### 6.2.3.3 Sequence Number (SN) field

Length: 12 bits or 18 bits (configurable) for AMD PDU. 6 bits or 12 bits (configurable) for UMD PDU.

The SN field indicates the sequence number of the corresponding RLC SDU. For RLC AM, the sequence number is incremented by one for every RLC SDU. For RLC UM, the sequence number is incremented by one for every segmented RLC SDU.

### 6.2.3.4 Segmentation Info (SI) field

Length: 2 bits.

The SI field indicates whether an RLC PDU contains a complete RLC SDU or the first, middle, last segment of an RLC SDU.

**Table 6.2.3.4-1: SI field interpretation**

Value	Description
00	Data field contains all bytes of an RLC SDU
01	Data field contains the first segment of an RLC SDU
10	Data field contains the last segment of an RLC SDU
11	Data field contains neither the first nor last segment of an RLC SDU

### 6.2.3.5 Segment Offset (SO) field

Length: 16 bits

The SO field indicates the position of the RLC SDU segment in bytes within the original RLC SDU. Specifically, the SO field indicates the position within the original RLC SDU to which the first byte of the RLC SDU segment in the Data field corresponds. The first byte of the original RLC SDU is referred by the SO field value "0000000000000000", i.e., numbering starts at zero.

### 6.2.3.6 Data/Control (D/C) field

Length: 1 bit.

The D/C field indicates whether the RLC PDU is an RLC data PDU or RLC control PDU. The interpretation of the D/C field is provided in Table 6.2.3.6-1.

**Table 6.2.3.6-1: D/C field interpretation**

Value	Description
0	Control PDU
1	Data PDU

### 6.2.3.7 Polling bit (P) field

Length: 1 bit.

The P field indicates whether or not the transmitting side of an AM RLC entity requests a STATUS report from its peer AM RLC entity. The interpretation of the P field is provided in Table 6.2.3.7-1.

**Table 6.2.3.7-1: P field interpretation**

Value	Description
0	Status report not requested
1	Status report is requested

### 6.2.3.8 Reserved (R) field

Length: 1 bit.

The R field is a reserved field for this release of the protocol. The transmitting entity shall set the R field to "0". The receiving entity shall ignore this field.

### 6.2.3.9 Control PDU Type (CPT) field

Length: 3 bits.

The CPT field indicates the type of the RLC control PDU. The interpretation of the CPT field is provided in Table 6.2.3.9-1.

**Table 6.2.3.9-1: CPT field interpretation**

Value	Description
000	STATUS PDU
001-	Reserved (PDUs with this coding will be discarded by the receiving entity for this release of the protocol)

### 6.2.3.10 Acknowledgement SN (ACK\_SN) field

Length: 12 bits or 18 bits (configurable).

The ACK\_SN field indicates the SN of the next not received RLC SDU which is not reported as missing in the STATUS PDU. When the transmitting side of an AM RLC entity receives a STATUS PDU, it interprets that all RLC SDUs up to but not including the RLC SDU with SN = ACK\_SN have been received by its peer AM RLC entity, excluding those RLC SDUs indicated in the STATUS PDU with NACK\_SN, portions of RLC SDUs indicated in the STATUS PDU with NACK\_SN, SOstart and SOend, RLC SDUs indicated in the STATUS PDU with NACK\_SN and NACK\_range, and portions of RLC SDUs indicated in the STATUS PDU with NACK\_SN, NACK range, SOstart and SOend.

### 6.2.3.11 Extension bit 1 (E1) field

Length: 1 bit.

The E1 field indicates whether or not a set of NACK\_SN, E1, E2 and E3 follows. The interpretation of the E1 field is provided in Table 6.2.3.11-1.

**Table 6.2.3.11-1: E1 field interpretation**

Value	Description
0	A set of NACK_SN, E1, E2 and E3 does not follow.
1	A set of NACK_SN, E1, E2 and E3 follows.

### 6.2.3.12 Negative Acknowledgement SN (NACK\_SN) field

Length: 12 bits or 18 bits (configurable).

The NACK\_SN field indicates the SN of the RLC SDU (or RLC SDU segment) that has been detected as lost at the receiving side of the AM RLC entity.

### 6.2.3.13 Extension bit 2 (E2) field

Length: 1 bit.

The E2 field indicates whether or not a set of SOstart and SOend follows. The interpretation of the E2 field is provided in Table 6.2.3.13-1.

**Table 6.2.3.13-1: E2 field interpretation**

Value	Description
0	A set of SOstart and SOend does not follow for this NACK_SN.
1	A set of SOstart and SOend follows for this NACK_SN.

### 6.2.3.14 SO start (SOstart) field

Length: 16 bits.

The SOstart field (together with the SOend field) indicates the portion of the RLC SDU with SN = NACK\_SN (the NACK\_SN for which the SOstart is related to) that has been detected as lost at the receiving side of the AM RLC entity. Specifically, the SOstart field indicates the position of the first byte of the portion of the RLC SDU in bytes within the original RLC SDU. The first byte of the original RLC SDU is referred by the SOstart field value "0000000000000000", i.e., numbering starts at zero.

### 6.2.3.15 SO end (SOend) field

Length: 16 bits.

When E3 is 0, the SOend field (together with the SOstart field) indicates the portion of the RLC SDU with SN = NACK\_SN (the NACK\_SN for which the SOend is related to) that has been detected as lost at the receiving side of the AM RLC entity. Specifically, the SOend field indicates the position of the last byte of the portion of the RLC SDU in bytes within the original RLC SDU. The first byte of the original RLC SDU is referred by the SOend field value "0000000000000000", i.e., numbering starts at zero. The special SOend value "1111111111111111" is used to indicate that the missing portion of the RLC SDU includes all bytes to the last byte of the RLC SDU.

When E3 is 1, the SOend field indicates the portion of the RLC SDU with SN = NACK\_SN + NACK range - 1 that has been detected as lost at the receiving side of the AM RLC entity. Specifically, the SOend field indicates the position of the last byte of the portion of the RLC SDU in bytes within the original RLC SDU. The first byte of the original RLC SDU is referred by the SOend field value "0000000000000000", i.e., numbering starts at zero. The special SOend value "1111111111111111" is used to indicate that the missing portion of the RLC SDU includes all bytes to the last byte of the RLC SDU.

### 6.2.3.16 Extension bit 3 (E3) field

Length: 1 bit.

The E3 field indicates whether or not information about a continuous sequence of RLC SDUs that have not been received follows.

**Table 6.2.3.16-1: E3 field interpretation**

Value	Description
0	NACK range field does not follow for this NACK_SN.
1	NACK range field follows for this NACK_SN.

### 6.2.3.17 NACK range field

Length: 8 bits

This NACK range field is the number of consecutively lost RLC SDUs starting from and including NACK\_SN.

---

## 7 Variables, constants and timers

### 7.1 State variables

This sub clause describes the state variables used in AM and UM entities in order to specify the RLC protocol. The state variables defined in this clause are normative.

All state variables and all counters are non-negative integers.

All state variables related to AM data transfer can take values from 0 to 4095 for 12 bit SN or from 0 to 262143 for 18 bit SN. All arithmetic operations contained in the present document on state variables related to AM data transfer are affected by the AM modulus (i.e. final value = [value from arithmetic operation] modulo 4096 for 12 bit SN and 262144 for 18 bit SN).

All state variables related to UM data transfer can take values from 0 to 63 for 6 bit SN or from 0 to 4095 for 12 bit SN. All arithmetic operations contained in the present document on state variables related to UM data transfer are affected by the UM modulus (i.e. final value = [value from arithmetic operation] modulo 64 for 6 bit SN and 4096 for 12 bit SN).

When performing arithmetic comparisons of state variables or SN values, a modulus base shall be used.

TX\_Next\_Ack and RX\_Next shall be assumed as the modulus base at the transmitting side and receiving side of an AM RLC entity, respectively. This modulus base is subtracted from all the values involved, and then an absolute comparison is performed (e.g.  $RX\_Next \leq SN < RX\_Next + AM\_Window\_Size$  is evaluated as  $[RX\_Next - RX\_Next] \bmod 2^{[sn-FieldLength]} \leq [SN - RX\_Next] \bmod 2^{[sn-FieldLength]} < [RX\_Next + AM\_Window\_Size - RX\_Next] \bmod 2^{[sn-FieldLength]}$ ), where *sn-FieldLength* is 12 or 18 for 12 bit SN and 18 bit SN, respectively.

$RX\_Next\_Highest - UM\_Window\_Size$  shall be assumed as the modulus base at the receiving UM RLC entity. This modulus base is subtracted from all the values involved, and then an absolute comparison is performed (e.g.  $(RX\_Next\_Highest - UM\_Window\_Size) \leq SN < RX\_Next\_Highest$  is evaluated as  $[(RX\_Next\_Highest - UM\_Window\_Size) - (RX\_Next\_Highest - UM\_Window\_Size)] \bmod 2^{[sn-FieldLength]} \leq [SN - (RX\_Next\_Highest - UM\_Window\_Size)] \bmod 2^{[sn-FieldLength]} < [RX\_Next\_Highest - (RX\_Next\_Highest - UM\_Window\_Size)] \bmod 2^{[sn-FieldLength]}$ ), where *sn-FieldLength* is 6 or 12 for 6 bit SN and 12 bit SN, respectively.

The transmitting side of each AM RLC entity shall maintain the following state variables:

a) TX\_Next\_Ack – Acknowledgement state variable

This state variable holds the value of the SN of the next RLC SDU for which a positive acknowledgment is to be received in-sequence, and it serves as the lower edge of the transmitting window. It is initially set to 0, and is updated whenever the AM RLC entity receives a positive acknowledgment for an RLC SDU with SN = TX\_Next\_Ack.

## b) TX\_Next – Send state variable

This state variable holds the value of the SN to be assigned for the next newly generated AMD PDU. It is initially set to 0, and is updated whenever the AM RLC entity constructs an AMD PDU with SN = TX\_Next and contains an RLC SDU or the last segment of a RLC SDU.

## c) POLL\_SN – Poll send state variable

This state variable holds the value of the highest SN of the AMD PDU among the AMD PDUs submitted to lower layer when POLL\_SN is set according to sub clause 5.3.3.2. It is initially set to 0.

The transmitting side of each AM RLC entity shall maintain the following counters:

## a) PDU\_WITHOUT\_POLL – Counter

This counter is initially set to 0. It counts the number of AMD PDUs sent since the most recent poll bit was transmitted.

## b) BYTE\_WITHOUT\_POLL – Counter

This counter is initially set to 0. It counts the number of data bytes sent since the most recent poll bit was transmitted.

## c) RETX\_COUNT – Counter

This counter counts the number of retransmissions of an RLC SDU or RLC SDU segment (see clause 5.3.2). There is one RETX\_COUNT counter maintained per RLC SDU.

The receiving side of each AM RLC entity shall maintain the following state variables:

## a) RX\_Next – Receive state variable

This state variable holds the value of the SN following the last in-sequence completely received RLC SDU, and it serves as the lower edge of the receiving window. It is initially set to 0, and is updated whenever the AM RLC entity receives an RLC SDU with SN = RX\_Next.

b) RX\_Next\_Status\_Trigger – *t-Reassembly* state variable

This state variable holds the value of the SN following the SN of the RLC SDU which triggered *t-Reassembly*.

## c) RX\_Highest\_Status – Maximum STATUS transmit state variable

This state variable holds the highest possible value of the SN which can be indicated by "ACK\_SN" when a STATUS PDU needs to be constructed. It is initially set to 0.

## d) RX\_Next\_Highest – Highest received state variable

This state variable holds the value of the SN following the SN of the RLC SDU with the highest SN among received RLC SDUs. It is initially set to 0.

Each transmitting UM RLC entity shall maintain the following state variables:

## a) TX\_Next – UM send state variable

This state variable holds the value of the SN to be assigned for the next newly generated UMD PDU with segment. It is initially set to 0, and is updated after the UM RLC entity submits a UMD PDU including the last segment of an RLC SDU to lower layers.

Each receiving UM RLC entity shall maintain the following state variables:

## a) RX\_Next\_Reassembly – UM receive state variable

This state variable holds the value of the earliest SN that is still considered for reassembly. It is initially set to 0. For groupcast and broadcast of NR sidelink communication, it is initially set to the SN of the first received UMD PDU containing an SN.

b) *RX\_Timer\_Trigger* – UM *t-Reassembly* state variable

This state variable holds the value of the SN following the SN which triggered *t-Reassembly*.

c) *RX\_Next\_Highest*– UM receive state variable

This state variable holds the value of the SN following the SN of the UMD PDU with the highest SN among received UMD PDUs. It serves as the higher edge of the reassembly window. It is initially set to 0. For groupcast and broadcast of NR sidelink communication, it is initially set to the SN of the first received UMD PDU containing an SN.

## 7.2 Constants

a) *AM\_Window\_Size*

This constant is used by both the transmitting side and the receiving side of each AM RLC entity. *AM\_Window\_Size* = 2048 when a 12 bit SN is used, *AM\_Window\_Size* = 131072 when an 18 bit SN is used.

b) *UM\_Window\_Size*

This constant is used by the receiving UM RLC entity to define SNs of those UMD SDUs that can be received without causing an advancement of the receiving window. *UM\_Window\_Size* = 32 when a 6 bit SN is configured, *UM\_Window\_Size* = 2048 when a 12 bit SN is configured.

## 7.3 Timers

The following timers are configured by TS 38.331 [5]:

a) *t-PollRetransmit*

This timer is used by the transmitting side of an AM RLC entity in order to retransmit a poll (see sub clause 5.3.3).

b) *t-Reassembly*

This timer is used by the receiving side of an AM RLC entity and receiving UM RLC entity in order to detect loss of RLC PDUs at lower layer (see sub clauses 5.2.2.2 and 5.2.3.2). If *t-Reassembly* is running, *t-Reassembly* shall not be started additionally, i.e. only one *t-Reassembly* per RLC entity is running at a given time.

c) *t-StatusProhibit*

This timer is used by the receiving side of an AM RLC entity in order to prohibit transmission of a STATUS PDU (see sub clause 5.3.4).

## 7.4 Configurable parameters

The following parameters are configured by TS 38.331 [5]:

a) *maxRetxThreshold*

This parameter is used by the transmitting side of each AM RLC entity to limit the number of retransmissions corresponding to an RLC SDU, including its segments (see clause 5.3.2).

b) *pollPDU*

This parameter is used by the transmitting side of each AM RLC entity to trigger a poll for every *pollPDU* PDUs (see clause 5.3.3).

c) *pollByte*

This parameter is used by the transmitting side of each AM RLC entity to trigger a poll for every *pollByte* bytes (see clause 5.3.3).

---

## Annex A (informative): Change history

Change history							
Date	Meeting	TDoc	CR	Rev	Cat	Subject/Comment	New version
2017-04	RAN2#97bis	R2-1703648				Skeleton of NR RLC specification	x.y.z
2017-05	RAN2#98	R2-1705513				Initial draft TS capturing outcome of email discussion [97bis#25]	0.0.2
2017-06	RAN#98	R2-1707257				Draft TS capturing outcome of email discussion [98#36]	0.1.0
2017-07	RAN2 NR AH#2	R2-1707508				Draft TS capturing outcome of email discussion [NR-AH2#06]	0.2.0
2017-08	RAN2#99	R2-1709752				Draft TS capturing outcome of email discussion [99#11]	0.3.0
2017-09	RAN#77	RP-171883				Submitted to RAN for information	1.0.0
2017-10	RAN2#99bis	R2-1712478				Draft TS capturing outcome of email discussion [99bis#13]	1.1.0
2017-12	RAN2#100	R2-1714261				Draft TS capturing outcome of email discussion [100#21]	1.2.0
2017-12	RP-78	RP-172322				Submitted to RAN for approval	2.0.0
2017-12	RP-78					Upgraded to Rel-15	15.0.0
2018-03	RP-79	RP-180440	0003	-	F	Corrections for RLC specification	15.1.0
2018-06	RP-80	RP-181214	0009	1	F	CR on updating POLL_SN value and selecting the RLC SDU for retransmission	15.2.0
2018-09	RP-81	RP-181939	0018	1	F	Remaining corrections on TS 38.322	15.3.0
2018-12	RP-82	RP-182658	0028	1	F	Ambiguity of POLL_SN update timing	15.4.0
2019-03	RP-83	RP-190540	0029	1	D	Corrections on RLC state variables	15.5.0
2020-03	RP-87	RP-200346	0030	1	B	CR for 38.322 for NR V2X	16.0.0
2020-07	RP-88	RP-201179	0036	1	F	Correction on RLC spec to support the BAP as upper layer	16.1.0
2020-12	RP-90	RP-202772	0037	1	F	CR to 38.322 on Backhaul RLC Channel	16.2.0